

Article number: 54301328

Description: LDK Rod end PHS 28

Measures

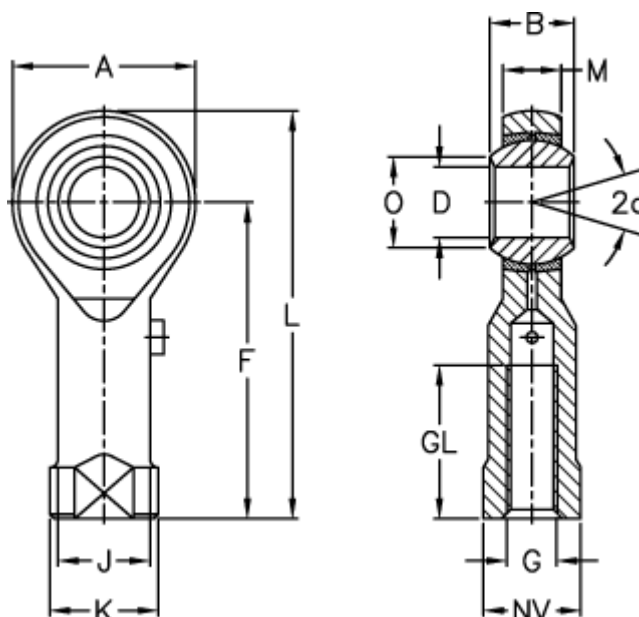

A	= 66	J	= 37.0
a (degrees)	= 15	K	= 46
B	= 35	L	= 136
D	= 28	M	= 25.00
Dynamic load C (kN)	= 46.0	NV	= 41
F	= 103	O	= 32.29
g	= M27x2	Static load C0 (kN)	= 75.0
GL	= 53	Weight (g)	= 950.0